



# MCM68766

## 8192 x 8-BIT UV ERASABLE PROM

The MCM68766 is a 65,536-bit Erasable and Electrically Reprogrammable PROM designed for system debug usage and similar applications requiring nonvolatile memory that could be reprogrammed periodically, or for replacing 64K ROMs for fast turnaround time. The transparent window on the package allows the memory content to be erased with ultraviolet light.

For ease of use, the device operates from a single power supply that has an output enable control and is pin-for-pin compatible with the MCM68366 mask programmable ROMs, which are available for large volume production runs of systems initially using the MCM68766.

- Single +5 V Power Supply
- Organized as 8192 Bytes of 8 Bits
- Fully TTL Compatible
- Maximum Access Time = 450 ns MCM68766  
400 ns MCM68766-40  
350 ns MCM68766-35  
300 ns MCM68766-30
- Standard 24-Pin DIP for EPROM Upgradability
- Pin Compatible to MCM68366 Mask Programmable ROM
- Low Power Dissipation — 85 mA Active Maximum
- Fast Programming Algorithm Possible

## MOS

(N-CANNEL, SILICON-GATE)  
8192 x 8-BIT  
UV ERASABLE  
PROGRAMMABLE READ  
ONLY MEMORY

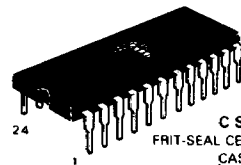

C SUFFIX  
FRIT-SEAL CERAMIC PACKAGE  
CASE 623A

### BLOCK DIAGRAM

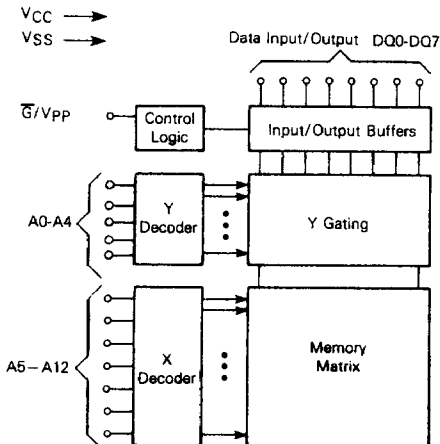

### PIN ASSIGNMENT

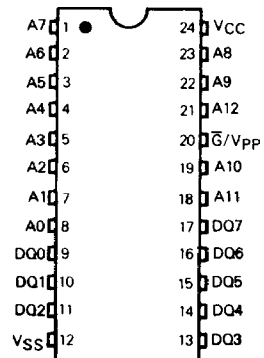

### Pin Names

A	.....	Address
DQ	.....	Data Input/Output
G/Vpp	.....	Output Enable/Program
VCC	.....	+ 5 V Power Supply
VSS	.....	Ground

EPROM

# MCM68766

## ABSOLUTE MAXIMUM RATINGS

Rating	Value	Unit
Temperature Under Bias	-10 to +80	°C
Operating Temperature Range	0 to +70	°C
Storage Temperature	-65 to +125	°C
All Input or Output Voltages with Respect to V <sub>SS</sub>	+6 to -0.3	Vdc
V <sub>PP</sub> Supply Voltage with Respect to V <sub>SS</sub>	+28 to -0.3	Vdc

This device contains circuitry to protect the inputs against damage due to high static voltages or electric fields; however, it is advised that normal precautions be taken to avoid application of any voltage higher than maximum rated voltages to this high-impedance circuit.

NOTE: Permanent device damage may occur if ABSOLUTE MAXIMUM RATINGS are exceeded. Functional operation should be restricted to RECOMMENDED OPERATING CONDITIONS. Exposure to higher than recommended voltages for extended periods of time could affect device reliability.

## MODE SELECTION

Mode	Pin Number			
	9-11, 13-17, DQ	12 V <sub>SS</sub>	20 $\bar{G}/V_{PP}$	24 V <sub>CC</sub>
Read	Data Out	V <sub>SS</sub>	V <sub>IL</sub>	V <sub>CC</sub>
Output Disable	High-Z	V <sub>SS</sub>	V <sub>IH</sub>	V <sub>CC</sub>
Program	Data In	V <sub>SS</sub>	Pulsed V <sub>ILP</sub> to V <sub>IHP</sub>	V <sub>CC</sub>

EPROM

FIGURE 1 — AC TEST LOAD

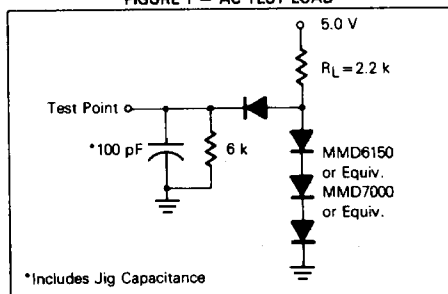

**DC OPERATING CONDITIONS AND CHARACTERISTICS**  
(Full operating voltage and temperature range unless otherwise noted)

**CAPACITANCE** (f = 1.0 MHz, T<sub>A</sub> = 25°C, V<sub>CC</sub> = 5 V periodically sampled rather than 100% tested)

Characteristic	Symbol	Typ	Max	Unit
Input Capacitance (V <sub>in</sub> = 0 V) Except $\bar{G}/V_{PP}$	C <sub>in</sub>	4.0	6.0	pF
Input Capacitance ( $\bar{G}/V_{PP}$ )	C <sub>in</sub>	60	100	pF
Output Capacitance (V <sub>out</sub> = 0 V)	C <sub>out</sub>	8.0	12	pF

Capacitance measured with a Boonton Meter or effective capacitance calculated from the equation: C = I<sub>Δt</sub>/ΔV.

**RECOMMENDED DC OPERATING CONDITIONS**

Parameter	Symbol	Min	Nom	Max	Unit
Supply Voltage	V <sub>CC</sub>	4.75	5.0	5.25	V
		4.50	5.0	5.50	
Input High Voltage	V <sub>IH</sub>	2.0	—	V <sub>CC</sub> + 1.0	V
Input Low Voltage	V <sub>IL</sub>	-0.1	—	0.8	V

**DC OPERATING CHARACTERISTICS**

Characteristic	Condition	Symbol	Min	Typ	Max	Units
Address Input Sink Current	V <sub>in</sub> = 5.25 V	I <sub>in</sub>	—	—	10	μA
Output Leakage Current	V <sub>out</sub> = 5.25 V	I <sub>LO</sub>	—	—	10	μA
$\bar{G}/V_{PP}$ Input Sink Current	$\bar{G}/V_{PP}$ = 0.4 V	I <sub>GL</sub>	—	—	100	μA
	$\bar{G}/V_{PP}$ = 2.4 V	I <sub>GH</sub> = I <sub>PL</sub>	—	—	100	μA
V <sub>CC</sub> Supply Current (Outputs Open)	$\bar{G}/V_{PP}$ = V <sub>IL</sub>	I <sub>CC</sub>	—	—	85	mA
Output Low Voltage	I <sub>OL</sub> = 2.1 mA	V <sub>OL</sub>	—	—	0.45	V
Output High Voltage	I <sub>OH</sub> = -400 μA	V <sub>OH</sub>	2.4	—	—	V

**AC OPERATING CONDITIONS AND CHARACTERISTICS**

(Full operating voltage and temperature range unless otherwise noted)

Input Pulse Levels ..... 0.8 Volt and 2.2 Volts      Output Timing Levels ..... 0.8 Volt and 2.0 Volts  
 Input Rise and Fall Times ..... 20 ns      Output Load ..... See Figure 1  
 Input Timing Levels ..... 1.0 Volt and 2.0 Volts

Characteristic	Symbol		MCM68766C 30		MCM68766C 35		MCM68766C 40		MCM68766C		Units
	Standard	Alternate	Min	Max	Min	Max	Min	Max	Min	Max	
Address Valid to Output Valid ( $\bar{G} = V_{IL}$ )	t <sub>AVQV</sub>	t <sub>ACC</sub>	—	300	—	350	—	400	—	450	ns
Output Enable to Output Valid	t <sub>GLOV</sub>	t <sub>OE</sub>	—	120	—	150	—	150	—	150	ns
Output Disable to Output High Z	t <sub>GHQZ</sub>	t <sub>DF</sub>	0	100	0	100	0	100	0	100	ns
Data Hold from Address ( $\bar{G} = V_{IL}$ )	t <sub>AXDX</sub>	t <sub>OH</sub>	0	—	0	—	0	—	0	—	ns

**READ MODE TIMING DIAGRAM**

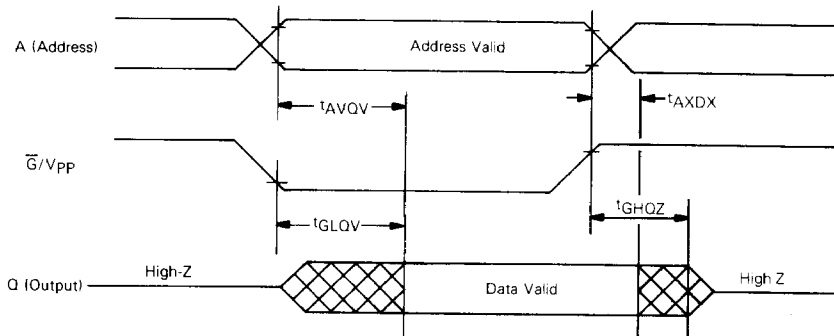

DC PROGRAMMING CONDITIONS AND CHARACTERISTICS  
( $T_A = 25 \pm 5^\circ\text{C}$ )

RECOMMENDED PROGRAMMING OPERATING CONDITIONS

Parameter	Symbol	Min	Nom	Max	Unit
Supply Voltage	$V_{CC}$	4.75	5.0	5.25	V
Input High Voltage for All Addresses and Data	$V_{IH}$	2.2	—	$V_{CC} + 1$	V
Input Low Voltage for All Addresses and Data	$V_{IL}$	-0.1	—	0.8	V
Program Pulse Input High Voltage	$V_{IHP}$	24	25	26	V
Program Pulse Input Low Voltage	$V_{ILP}$	2.0	$V_{CC}$	6.0	V

PROGRAMMING OPERATION DC CHARACTERISTICS

Characteristic	Condition	Symbol	Min	Typ	Max	Unit
Address Input Sink Current	$V_{in} = 5.25\text{ V}$	$I_{LI}$	—	—	10	$\mu\text{A}$
$V_{pp}$ Program Pulse Supply Current ( $V_{pp} = 25\text{ V} \pm 1\text{ V}$ )	—	$I_{PH}$	—	—	30	$\text{mA}$
$V_{pp}$ Supply Current ( $V_{pp} = 2.4\text{ V}$ )	—	$I_{PL} = I_{GH}$	—	—	100	$\mu\text{A}$
$V_{CC}$ Supply Current ( $V_{pp} = 5\text{ V}$ )	—	$I_{CC}$	—	—	85	$\text{mA}$

AC PROGRAMMING CONDITIONS AND CHARACTERISTICS

Characteristic	Symbol		Min	Max	Unit
	Standard	Alternate			
Address Setup Time	$t_{AVPH}$	$t_{AS}$	2.0	—	$\mu\text{s}$
Data Setup Time	$t_{DVPH}$	$t_{DS}$	2.0	—	$\mu\text{s}$
Output Enable to Valid Data	$t_{GLOV}$	$t_{OE}$	150	—	ns
Output Disable to Data In	$t_{GHQV}$	$t_{ODD}$	2.0	—	$\mu\text{s}$
Program Pulse Width	$t_{PHPL}$	$t_{PV}$	1.9	2.1	ms
Program Pulse Rise Time	$t_{PR}$	$t_{PR}$	0.5	2.0	$\mu\text{s}$
Program Pulse Fall Time	$t_{PF}$	$t_{PF}$	0.5	2.0	$\mu\text{s}$
Cumulative Programming Time Per Word*	$t_{CP}$	$t_{CP}$	12	50	ms

\*If less than 25, two-millisecond pulses are required to verify programming then 5 additional two-millisecond pulses are required to ensure proper operating margins (i.e.,  $2\text{ ms} + 5 \times 2\text{ ms} = 12\text{ ms}$  minimum  $t_{CP}$ ).

PROGRAMMING OPERATION TIMING DIAGRAM

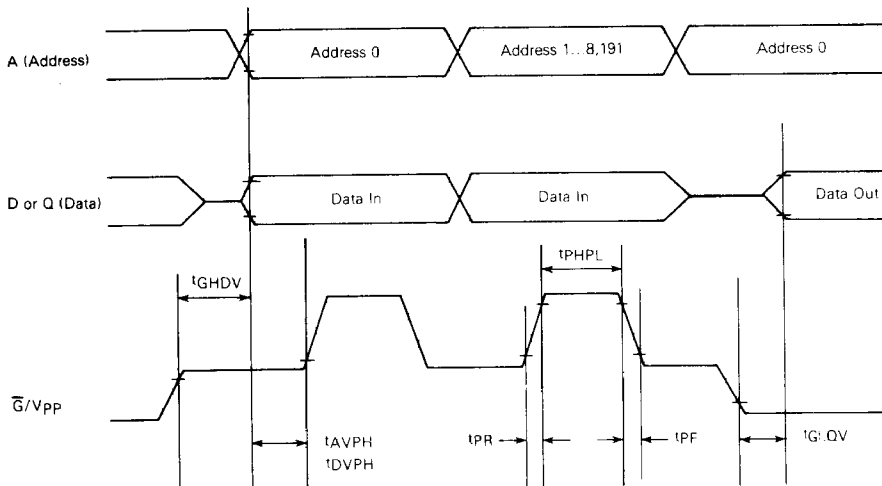

EPROM

## PROGRAMMING INSTRUCTIONS

Before programming, the memory should be submitted to a full erase operation to ensure that every bit is in the "1" state (represented by Output High). Data is entered by programming zeros (Output Low) into the required bits. The words are addressed the same way as in the READ operation. A programmed "0" can only be changed to a "1" by ultraviolet light erasure.

To set the memory up for Program Mode, the  $\overline{G}/V_{pp}$  input (Pin 20) should be between +2.0 and +6.0 V, which will three-state the outputs and allow data to be set up on the DQ terminals. The  $V_{CC}$  voltage is the same as for the Read operation. Only "0's" will be programmed when "0's" and "1's" are entered in the 8-bit data word.

After address and data setup, 25-volt programming pulse ( $V_{IH}$  to  $V_{IHP}$ ) is applied to the  $\overline{G}/V_{pp}$  input. The program pulse width is 2 ms and the maximum program pulse amplitude is 26 V.

Multiple MCM68766s may be programmed in parallel by connecting like inputs and applying the program pulse to the  $\overline{G}/V_{pp}$  inputs. Different data may be programmed into multiple MCM68766s connected in parallel by selectively applying the programming pulse only to the MCM68766s to be programmed.

## READ OPERATION

After access time, data is valid at the outputs in the Read mode. With  $\overline{G}/V_{pp} = "0"$  the outputs are enabled; with  $\overline{G}/V_{pp} = "1"$  the outputs are three-stated.

Multiple MCM68766s may share a common data bus with like outputs OR-tied together. In this configuration only one  $\overline{G}/V_{pp}$  input should be low and no other device outputs should be active on the same bus. This will prevent data contention on the bus.

## ERASING INSTRUCTIONS

The MCM68766 can be erased by exposure to high intensity shortwave ultraviolet light, with a wavelength of 2537 angstroms. The recommended integrated dose (i.e., UV-intensity X exposure time) is 15 Ws/cm<sup>2</sup>. As an example, using the "Model 30-000" UV Eraser (Turner Designs, Mountain View, CA 94043) the ERASE-time is 36 minutes. The lamps should be used without shortwave filters and the MCM68766 should be positioned about one inch away from the UV-tubes.

## RECOMMENDED OPERATING PROCEDURES

After erasure and reprogramming of the EPROM, it is recommended that the quartz window be covered with an opaque self-adhesive cover. It is important that the self-adhesive cover not leave any residue on the quartz if it is removed to allow another erasure.

FAST PROGRAMMING ALGORITHM

This device is capable of the fast programming algorithm as shown by the following flow chart. This algorithm allows for faster programming time with increased operating margins and improved reliability of data storage.

FAST PROGRAMMING ALGORITHM FLOW CHART

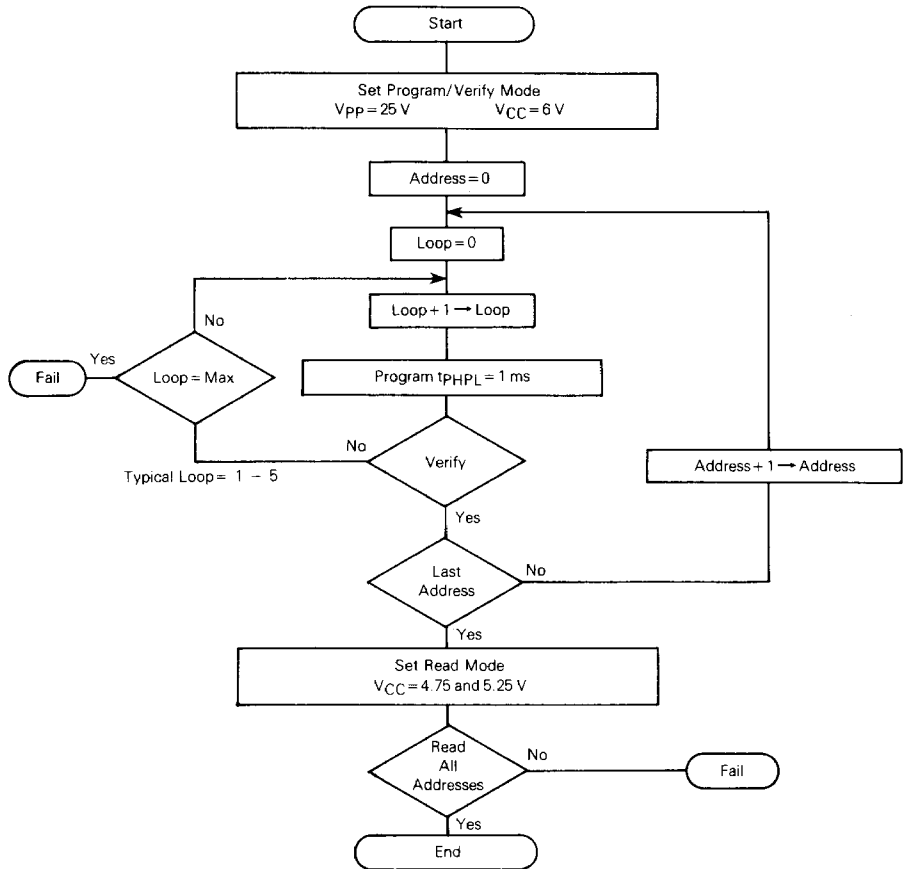

EPROM